

## Ante scorrevoli per armadi

Sliding doors for wardrobes  
Portes coulissantes pour armoires  
Schiebetüren für schränke



Anta Iks  
pagina 144



Waikiki  
pagina 146

## Anta Iks Scorrevole

Components

Eléments

Bestandteile

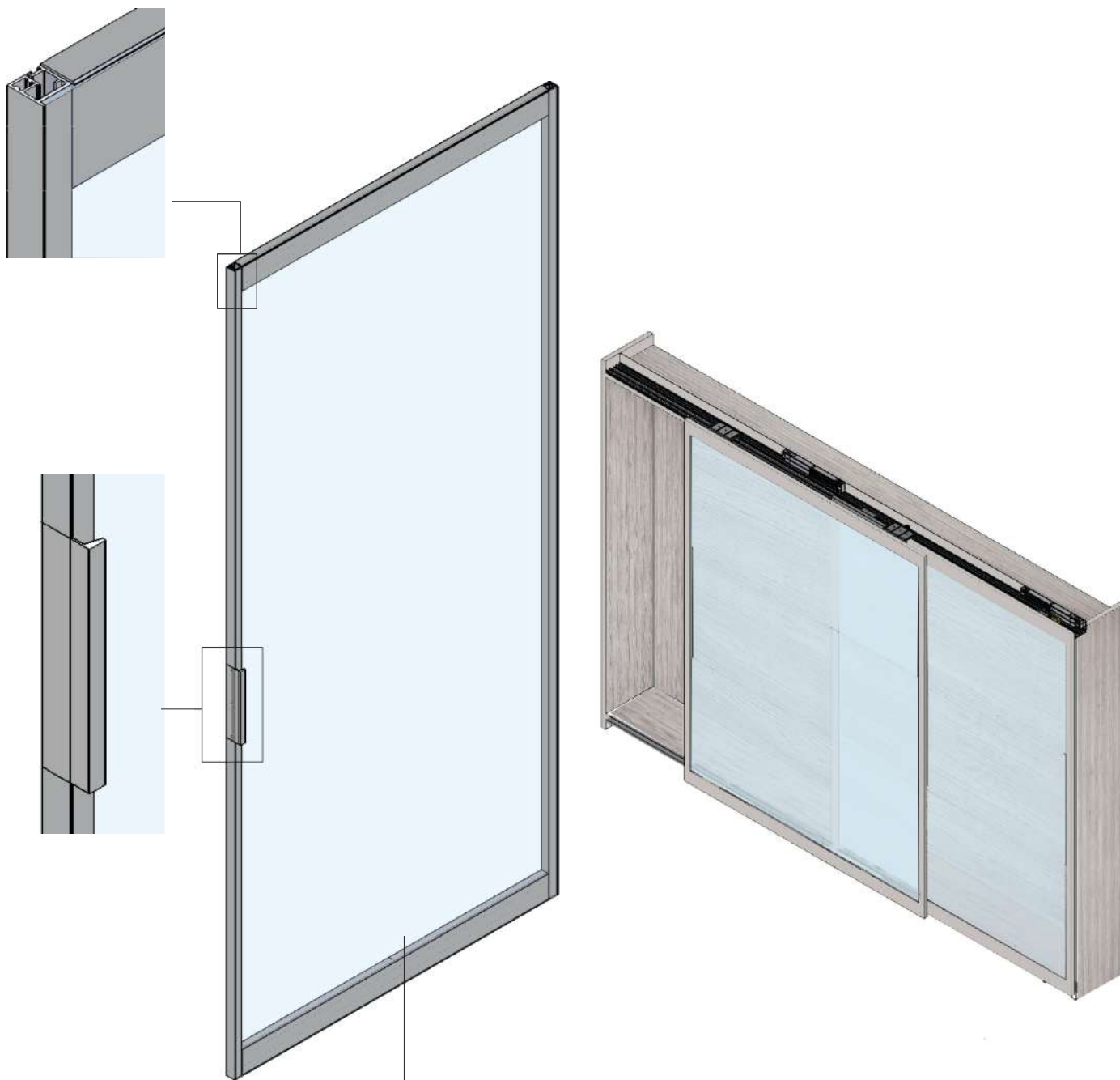

Vetro incollato

Glued glass  
Verre collé  
Geklebten glas

H/L vetro=H/L anta - 4.5

H/L Glass=H/L door - 4.5  
H/L Verre = porte - 4.5  
H/L Glas= Tür - 4.5

## Scorrevole componenti Anta Iks

Components  
Eléments  
Bestandteile

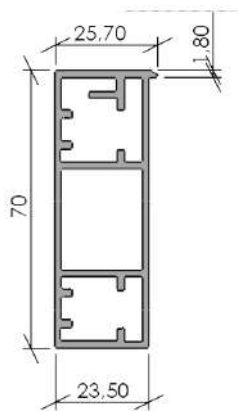

### IS-407 Traverso sup/inf anta

IS-407 Upper/lower profile  
IS-407 Profilé sup/inf  
IS-407 Oberes/unteres waagerechtes Profil

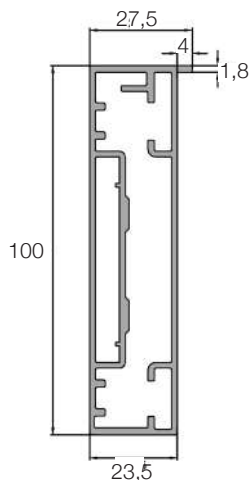

### IS-1051 Traverso sup/inf anta

PA-1051 Upper/lower profile  
PA-1051 Profilé sup/inf  
PA-1051 Oberes/unteres waagerechtes Profil

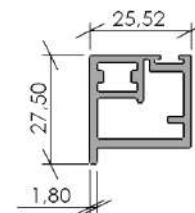

### IS-386 Montante verticale anta

IS-386 Vertical profile  
IS-386 Profilé vertical  
IS-386 Verticalprofil

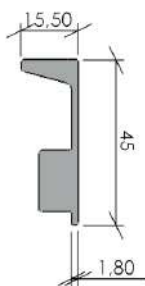

### IS-986 Profilo maniglia

IS-986 Handle profile  
IS-986 Profilé poignée  
IS-986 Griffprofil

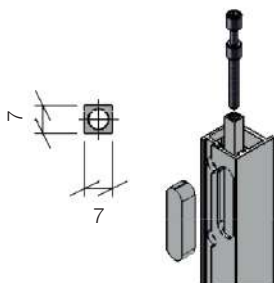

### IS-859 Profilo tirante anta in alluminio

IS-859 Tie-rod for aluminium door  
IS-859 Tirant pour porte  
IS-859 Zugstange



### A10.907 Giunto di collegamento profili telaio anta

A10.907 Connecting joint door profiles  
A10.907 Joint de connexion profilés cadre porte  
A10.907 Verbindungsstück für Alurahmenturprofil

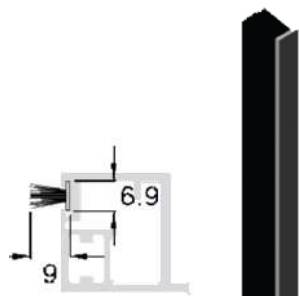

### SE-963 Profilo spazzolino di copertura

SE-963 Covering brush  
SE-963 Brosse de couverture  
SE-963 Deckbürste



### WK-100 Blocchetto e vite speciale per tirante

WK-100 Holder for tie-rod + special screw  
WK-100 Blochet et Vis pour tirant  
WK-100 Sperrung und spezielle Schraube

## Waikiki anta scorrevole **Presentazione**

Introduction  
Présentation  
Vorstellung



Waikiki è un'anta scorrevole per armadi realizzata con profili in alluminio che permettono l'inserimento di specchiature in vetro sp.4mm e in legno di sp. min 6 max 12mm. Il frontale in vista dell'anta è di 6mm. L'anta permette di inserire un raddrizzante in alluminio e usare carelli di scorrimento per spessori fino a 35mm

Waikiki: is a sliding door for furniture, made of aluminium profiles; it's possible to use glass 4mm and wooden panels from min.6mm to max 12mm. The part in view of the aluminium profile is 6mm. With this door it's possible to use an aluminium tie-rod and sliding carriages till 35mm of thickness.

Waikiki: est une porte coulissante pour armoires, réalisée avec profilés en aluminium anodisé qui permettent d'utiliser cadre en verre de 4mm ou en bois de minimum 6mm à maximum 12mm. La partie frontale en vue de la porte est de 6mm. Avec cette porte on peut utiliser un tirant en aluminium et des chariots de coulissement pour épaisseur jusqu'à 35mm.

Waikiki: ist eine Schiebetür für Schränke aus eloxierte Aluprofile. Diese Tür ermöglicht 4mm dicke Gläser und Holzpaneele von mindestens 6mm bis zu maximal 12mm zu verwenden. Die sichtbare Vorderseite ist 6mm dick. Mit dieser Tür ist es möglich eine Zugstange aus Aluminium und Laufrollen mit einer Stärke bis zum 35mm zu verwenden.

# Esplso anta scorrevole **Waikiki anta scorrevole**

Sliding door details  
Details porte coulissante  
Bestandteile

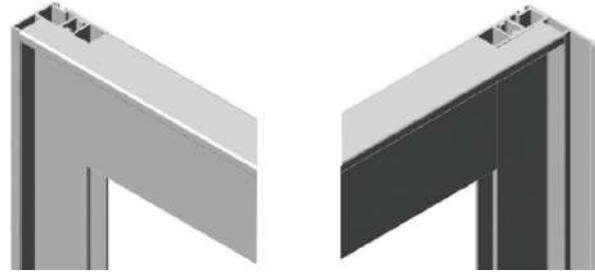

## WK-859 Tirante quadro

WK-859 Tie-rod  
WK-859 Tirant  
WK-859 Zugstange



## WK-387 Profilo maniglia

WK-387 Handle profile  
WK-387 Profilé poignée  
WK-387 Griffprofil

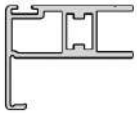

## Blocchetto vite per tirante

Holder for tie-rod+special screw  
Boîtier pour tirant+vis spécial  
Sperrung und spezielle Schraube



## Giunto di collegamento telaio anta

Connecting joints  
Joint de connexion  
Verbindungsstück für Alurahmentürprofile



## WK-407 Traverso sup/inf

WK-407 Upper/lower profile  
WK-407 Profilé sup/inf  
WK-407 Oberews/unteres waagerechtes Profil



## WK-388 Traverso centrale

WK-388 Devidign cross-bar  
WK-388 Traverse central  
WK-388 Aluquerträger zur abtrennung

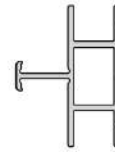

## WK-386 Profilo contromaniglia

WK-386 Couter handle profile  
WK-386 Profilé poignee exterieur  
WK-386 Äußeres Griffprofil

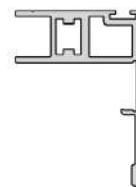

## WP-407 Traverso sup/inf

WK-407 Upper/lower profile  
WK-407 Profilé sup/inf  
WP-407 Oberews/unteres waagerechtes Profil



# Waikiki anta scorrevole **Caratteristiche tecniche**

Technical details  
 Caracteristiques techniques  
 Technische daten

## Sezione superiore/inferiore

Upper/lower section  
 Section supérieure/inférieure  
 Obere/untere Abschnitte

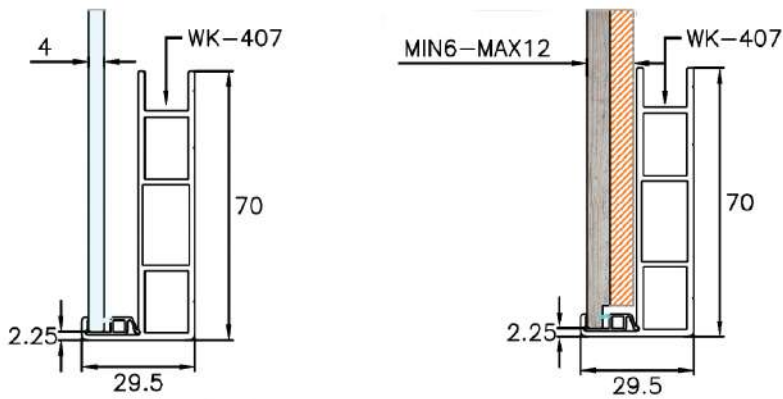

## Sezione intermedia

Middle section  
 Section intermédiaire  
 Mittelabschnitte

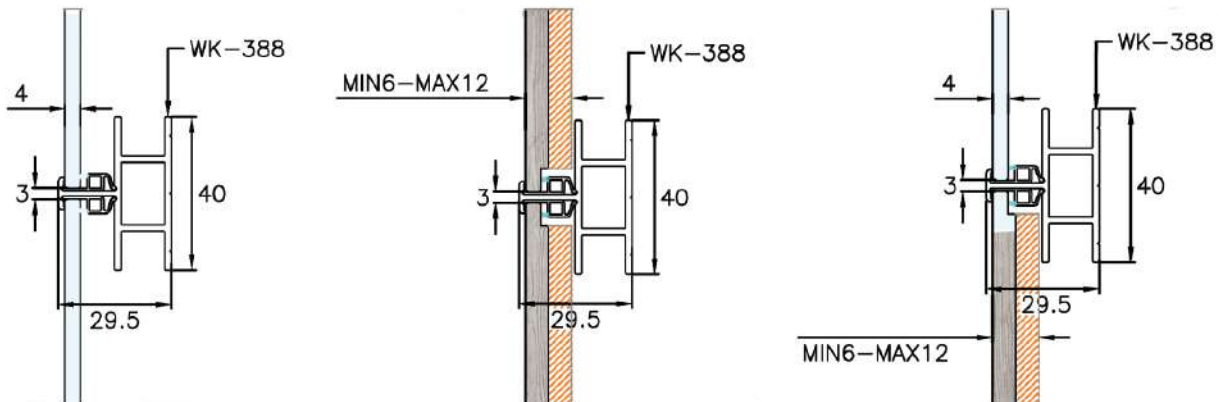

## Sezione orizzontali

Horizontal section  
 Section horizontal  
 Waagerechte Abschnitte

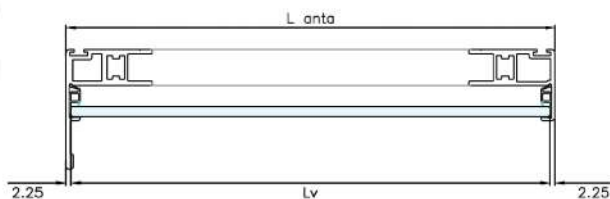

**L vetro= L anta - 5mm**

L glass= L door - 5mm  
 L verre= L porte - 5mm  
 L glas= L anta - 5mm

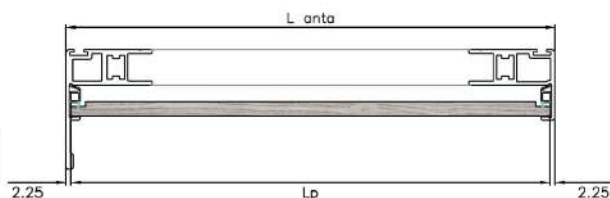

**L pannello= L anta - 5mm**

L panel= L door - 5mm  
 L panneau= L porte - 5mm  
 L paneel= L anta - 5mm

## Componenti anta scorrevole **Waikiki anta scorrevole**

Sliding door details  
Elements porte coulissante  
Bestandteile der schiebetur

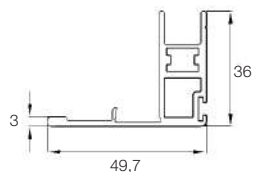

### WK-386 Profilo maniglia

WK-386 Outer handle profile  
WK-386 Profilé poignée extérieur  
WK-386 Äußeres Griffprofil

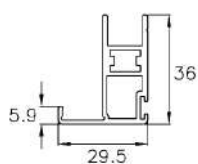

### WK-387 Profilo maniglia interna

WK-387 Inner handle profile  
WK-387 Profilé poignée intérieur  
WK-387 Inners Griffprofil

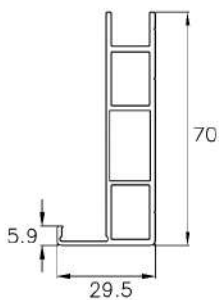

### WK-407 Profilo inferiore/superiore

WK-407 Upper and lower horizontal profile  
WK-407 Profilé supérieur/inférieur  
WK-407 Oberews/unteres waagerechtes Profil

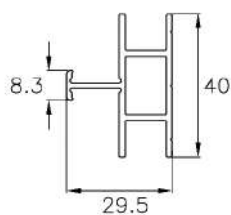

### WK-388 Profilo traversino

WK-388 Dividing cross-bar  
WK-388 Traverse central  
WK-388 Aluquerträger zur abtrennung

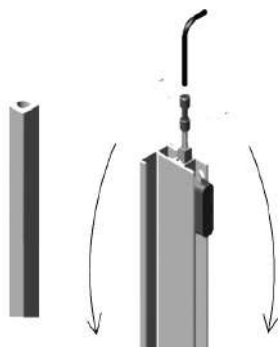
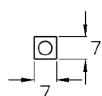

### WK-859 Profilo tirante anta in alluminio

WK-859 Tie-rod  
WK-859 Tirant pour porte  
WK-859 Zugstange

## Waikiki anta scorrevole Componenti anta scorrevole

Sliding door details  
Elements porte coulissante  
Bestandteile der schiebetur



A10.907 Giunto di collegamento profili telaio vetro:  
n.8 giunti per traverso sup/inf  
n.2 giunti per traversino  
n.3 viti M4x10 tsp per giunto

A10.907  
Connecting joint door profiles  
8 joints for upper/lower profiles  
2 joints for dividing cross-bar  
3 screw M4x10 tsp per each joint

A10.907  
Joint de connexion profilés cadre porte  
n.8 pcs. pour profilé sup/inf  
n.2 pcs pour traverse central  
n.3 vis M4x10 tsp par chaque joint

A10.907  
Verbindungsstück für Alurhamentürprofile  
8 Verbindungsstücke für oberes/unteres waagrechtes Profil  
2 Verbindungsstücke für Aluquerträger zur Abtrennung  
3 Schrauben M4x10 Senkschraube



WK-100 Blocchetto e vite speciale per tirare

WK-100 Holder for tie-rod+special screw  
WK-100 Boîtier et Vis pour tirant  
WK-100 Sperrung und spezielle Schraube



GWK4 Profilo guarnizione per vetro e pannello legno

GWK4 Gasket for glass and wooden panel  
GWK4 Joint pour verre et panneau en bois  
GWK4 Gummidichtung für Glas und Holzpaneel

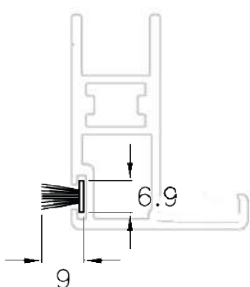

SE-963 Profilo spazzolino di copertura

SE-963 Covering brush  
SE-963 Brosse de couverture  
SE-963 Deckbürste



# Esploso anta battente **Waikiki anta battente**

Swing door details  
Details porte ouvrante  
Bestandteile der anschlagtur

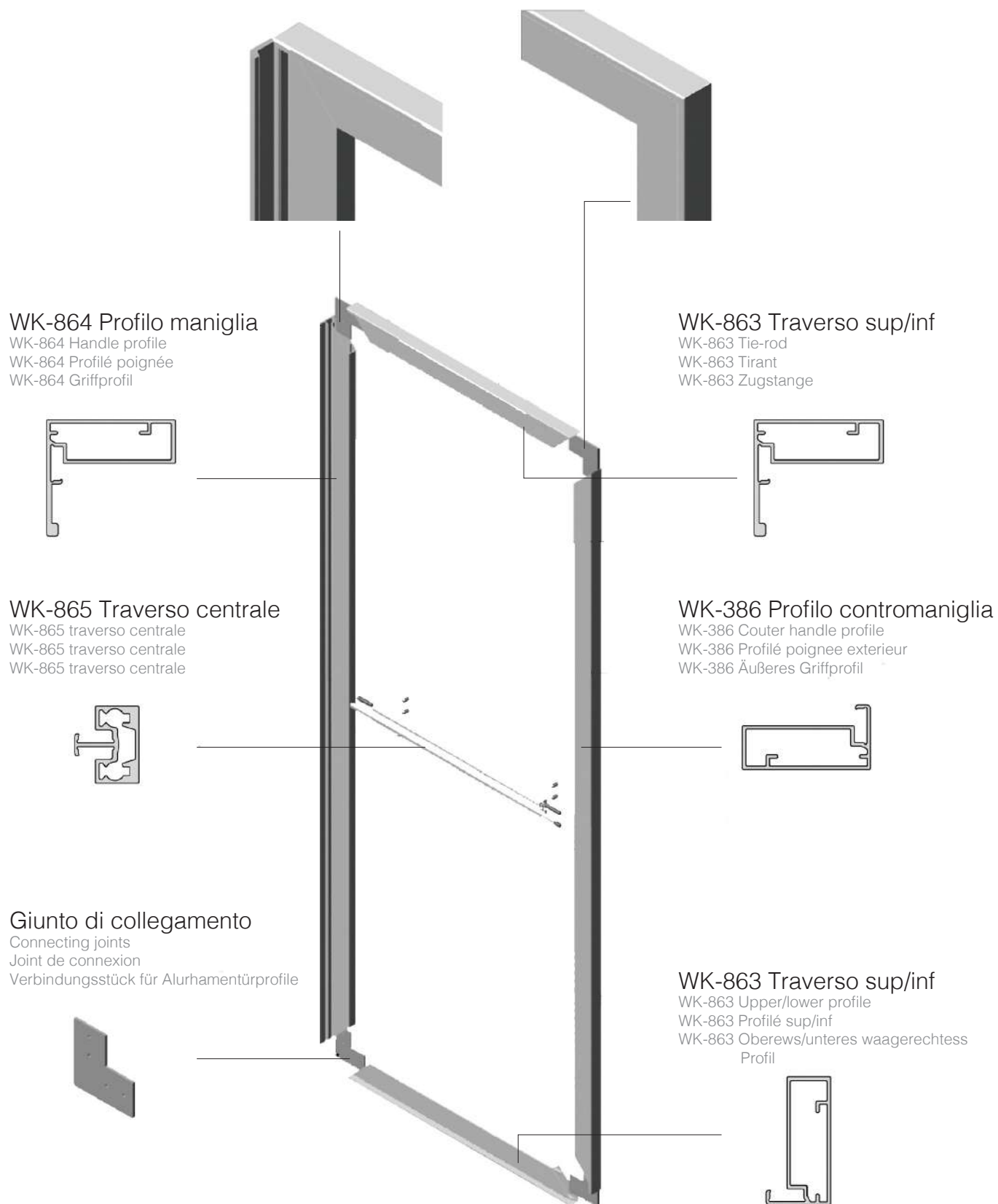

# Waikiki anta battente Caratteristiche tecniche

Technical details  
 Caracteristiques techniques  
 Technische daten

## Calcolo altezza vetri e pannelli

Glass height calculation  
 Calcul hauteur verres  
 Berechnungsregeln für Türhöhe

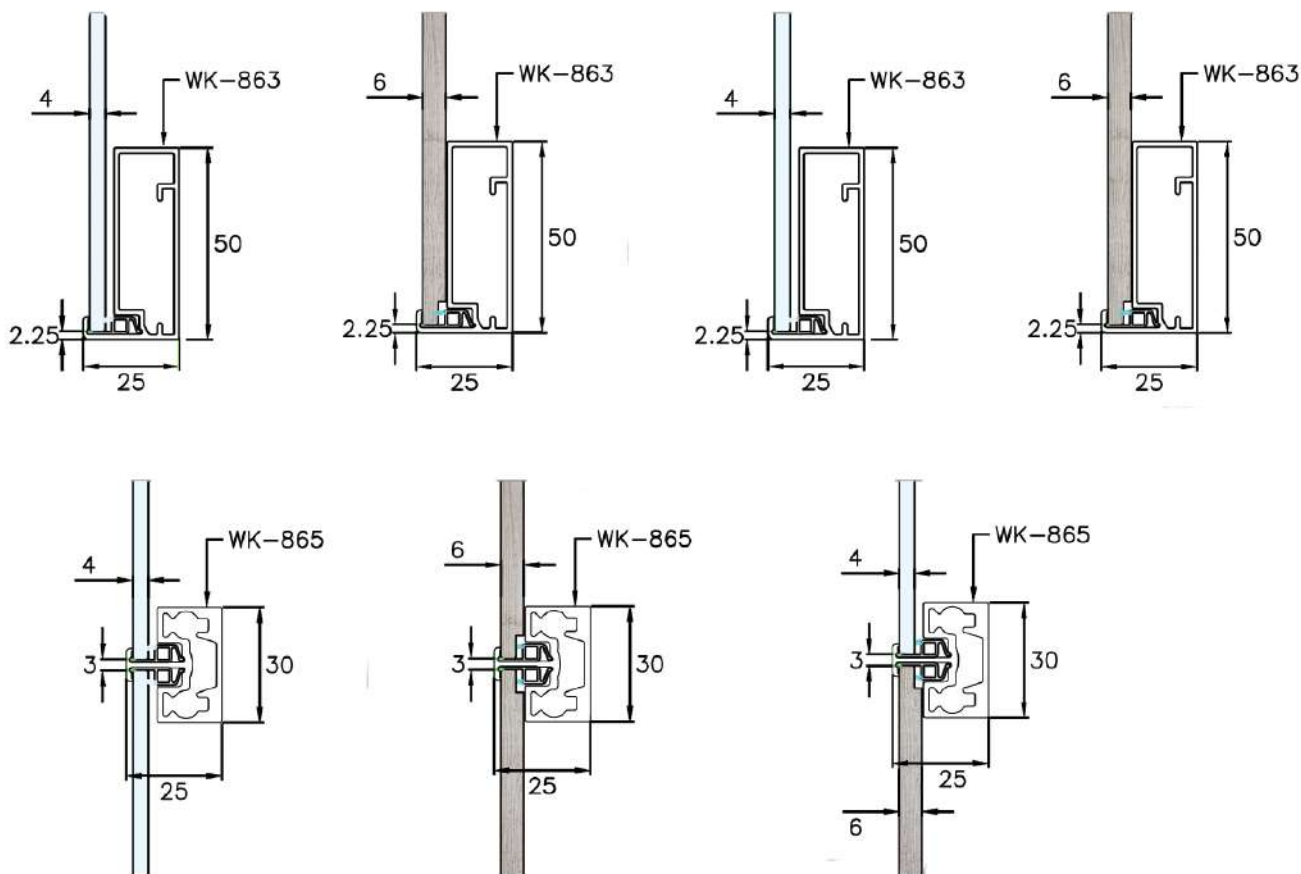

## Calcolo larghezza vetri e pannelli

Horizontal section  
 Section horizontal  
 Waagerechte Abschnitte

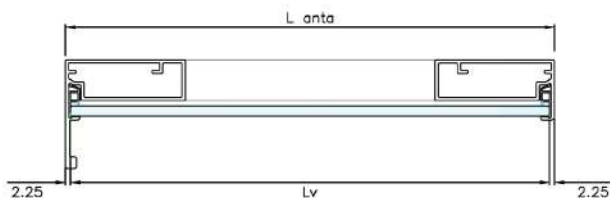

**L vetro= L anta - 5mm**

L glass= L door - 5mm  
 L verre= L porte - 5mm  
 L glas= L anta - 5mm

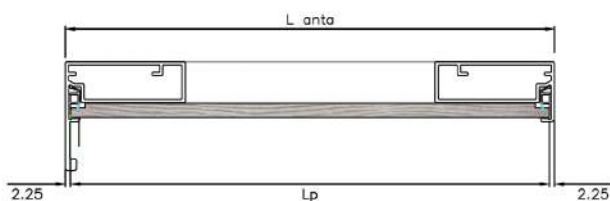

**L pannello= L anta - 5mm**

L panel= L door - 5mm  
 L panneau= L porte - 5mm  
 L paneel= L anta - 5mm

## Componenti anta battente **Waikiki anta battente**

Swing door components  
Elements porte ouvrante  
Bestandteile der anschlagtur

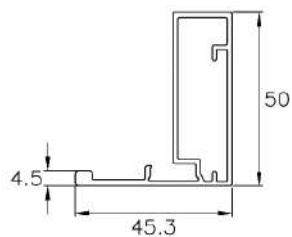

### WK-864 Profilo maniglia

WK-864 Outer handle profile  
WK-864 Profilé poignée extérieure  
WK-864 Äußeres Griffprofil

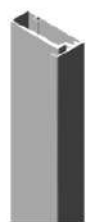
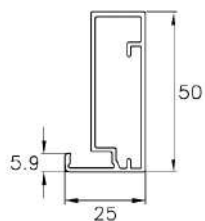

### WK-863 Profilo maniglia interna e traverso sup/inf

WK-863 Inner handle upper/lower profile  
WK-863 Profilé sup/inf poignée intérieure  
WK-863 Inneres Griffprofil

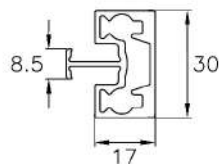

### WK-865 Profilo traversino

WK-865 Dividing cross-bar  
WK-865 Traverse central  
WK-865 Aluquerträger zur Abtrennung

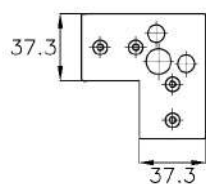

### A10.400 Giunto di collegamento telaio anta

A10.400 Connecting joint  
A10.400 Joint de connexion profilés cadre porte  
A10.400 Verbindungsstück

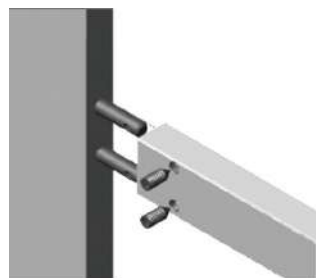

### Kit per fissaggio 1 traversino centrale:

n.4 tiranti articolo A10.478  
n.4 grani M6x6 articolo A10.934

Kit for cross profile insert:      Kit pour fixer un traverse central:  
n.4 tie-rod A10.478              n.4 tirants A10.478  
n.4 screws M6x6 A10.934      n.4 vis M6x6 A10.934

Bausatz zur Fixierung der Aluquerträger zur Abtrennung  
4 Zugstange A10.478  
4 Stifte M6x6 A10.934

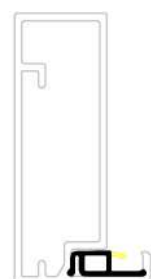

### GWK4 Profilo guarnizione per anta e pannellatura legno

GWK4 Gasket for glass and wooden panel  
GWK4 Joint pour verre et panneau en bois  
GWK4 Gummidichtung für Glas und Holzpaneel



| Time     | Phase | Mode | Control | Length | Priority | State | SP  |
|----------|-------|------|---------|--------|----------|-------|-----|
| 17:00:00 | Publi | Man  | 100-01  | 1:00   | 100      | 100   | 100 |
| 17:00:00 | Publi | Man  | 100-02  | 1:00   | 100      | 100   | 100 |
| 17:00:00 | Publi | Man  | 100-03  | 1:00   | 100      | 100   | 100 |
| 17:00:00 | Publi | Man  | 100-04  | 1:00   | 100      | 100   | 100 |
| 17:00:00 | Publi | Man  | 100-05  | 1:00   | 100      | 100   | 100 |
| 17:00:00 | Publi | Man  | 100-06  | 1:00   | 100      | 100   | 100 |
| 17:00:00 | Publi | Man  | 100-07  | 1:00   | 100      | 100   | 100 |
| 17:00:00 | Publi | Man  | 100-08  | 1:00   | 100      | 100   | 100 |
| 17:00:00 | Publi | Man  | 100-09  | 1:00   | 100      | 100   | 100 |
| 17:00:00 | Publi | Man  | 100-10  | 1:00   | 100      | 100   | 100 |
| 17:00:00 | Publi | Man  | 100-11  | 1:00   | 100      | 100   | 100 |
| 17:00:00 | Publi | Man  | 100-12  | 1:00   | 100      | 100   | 100 |
| 17:00:00 | Publi | Man  | 100-13  | 1:00   | 100      | 100   | 100 |
| 17:00:00 | Publi | Man  | 100-14  | 1:00   | 100      | 100   | 100 |
| 17:00:00 | Publi | Man  | 100-15  | 1:00   | 100      | 100   | 100 |
| 17:00:00 | Publi | Man  | 100-16  | 1:00   | 100      | 100   | 100 |
| 17:00:00 | Publi | Man  | 100-17  | 1:00   | 100      | 100   | 100 |
| 17:00:00 | Publi | Man  | 100-18  | 1:00   | 100      | 100   | 100 |
| 17:00:00 | Publi | Man  | 100-19  | 1:00   | 100      | 100   | 100 |
| 17:00:00 | Publi | Man  | 100-20  | 1:00   | 100      | 100   | 100 |